

Article number: 20141V20B202BL

Description: E+G two-way connecting clamp  
GN141-V20-B20-2-BL

## Measures

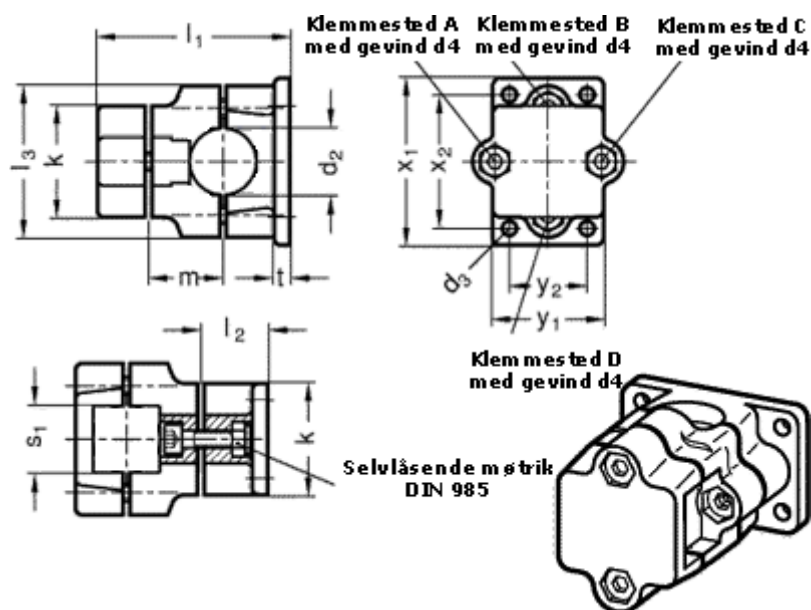

Adjustable clamp lever = GN 911-M 8-35 have to be ordred separately

$d_2$  = 20

$d_3$  = 7

$d_4$  = M 8

$k$  = 50

$l_1$  = 89

$l_2$  = 30

$l_3$  = 68

$m$  = 36

$s_1$  = 20

$t$  = 7

$x_1$  = 75

$x_2$  = 60

$y_1$  = 50

$y_2$  = 35